



深圳市泛科科技有限公司
Shenzhen Vanq Technology Co.,Ltd.

specification of T8 LED Tube Grow Light

Model No: VQ-GLT8020W-21/22/23/24/25/26

P/N: VQ-RD-GGS-GL010

Version: 1.0

Description:

- ◆ T8 1.2M 20W LED Tube Grow Light

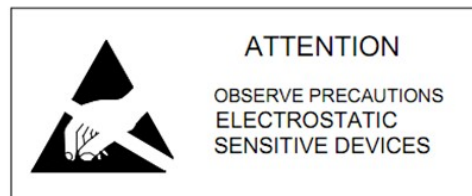

Tel.: +86-755-29042099

Fax: +86-755-82113652

Email: vanqled@vanqled.com

Website: www.vanqled.com

Address: 3/F , #B Building, DeBaoLi Industrial Zone, # 312 Jihua Road, Ban Tian Town,
Longgang District, Shenzhen City, GuangDong Pro., China 518129

Introduction:

1. It consist of semi-circle aluminium Alloy heatsink and PC lens; There are 20pcs 1w high power LED, internal 20w constant current LED power supply, High light intensity, low power dissipation.
2. Input voltage: AC85-265V, Convenient usage, application for all countries.
3. LED power supply with isolation project, safe usage.
4. Lifespan more than 50,000hours.
5. Aluminum Alloy with high heat conduction, make sure the normal working time.
6. Apply for plant growing, flowering, fructification.
7. Red light promote the flowering, fructification; Blue light promote the growth of leaf, you can customize different LED ratio according to different plants.

Product application:

1. As a supplementary lighting source, strengthen the light intensity, lengthen lighting time.
2. According to different plant needs, it can control the light which plant need.
3. In replacement of natural light in the greenhouse, efficiently promote the growth of plant.

1、 Dimension(unit: mm)

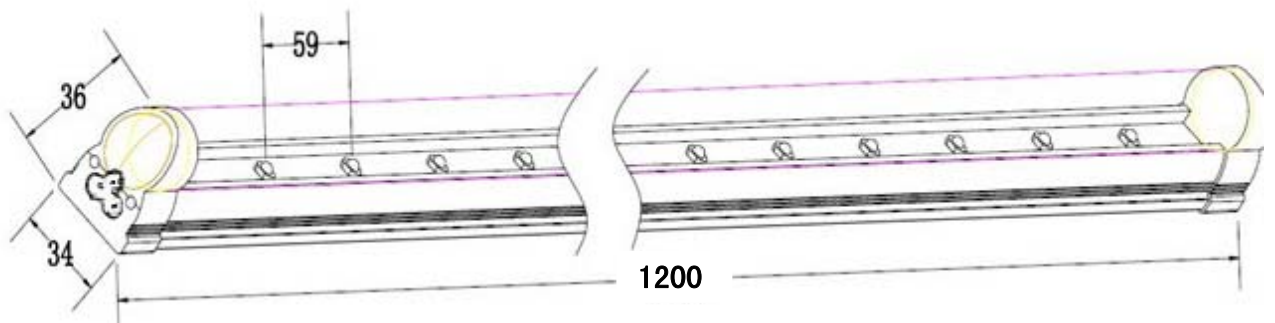

Picture 1: Dimension

二、 Products Images



Picture 2: picture

三、 Principle of Electrical Connections

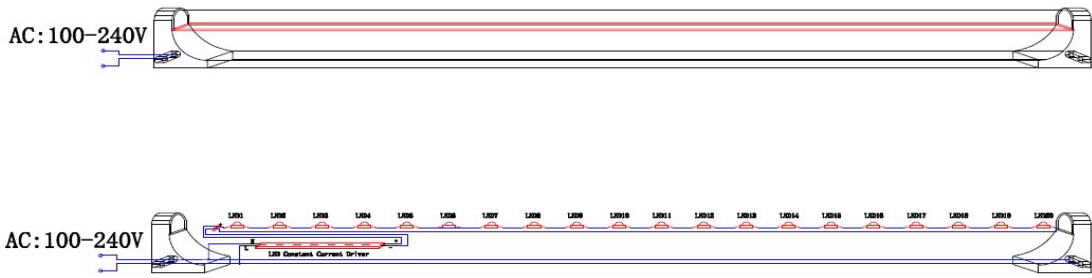

Picture 2: the principle of Electrical connection

四、Parameter

Item Model	VQ-GLT8020W
Called way	At one end
Input Voltage	AC85-265V
size(mm)	1200mm*34mm*36mm
Waterproof rate	
Material	Aluminium alloy +clear PC lens
Source	20pcs 1w high power led
light ratio of red and blue	
Power	20W
PCB Material	AL5052 PCB
Working temperature	-20~+50℃
Usage lifespan	≥25000Hours
Net weight	460g
Gross Weight	720g
Recommended Suspended Height	30CM
PPFD	35μmol/m ² /s

Note:

1、The wavelength of LED can be appointed by customers, the recommended wavelength of red light: 620-630nm,640-660nm; blue light:450-460nm,460-470nm.

五、Distribution of Light Intensity, Light Photon

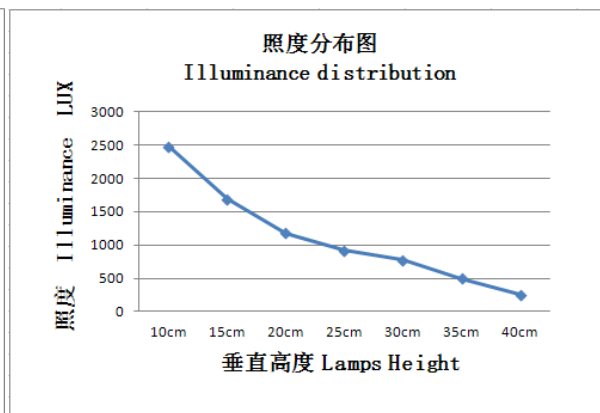
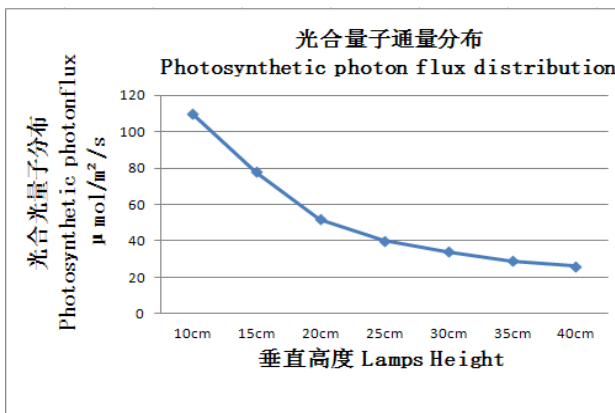

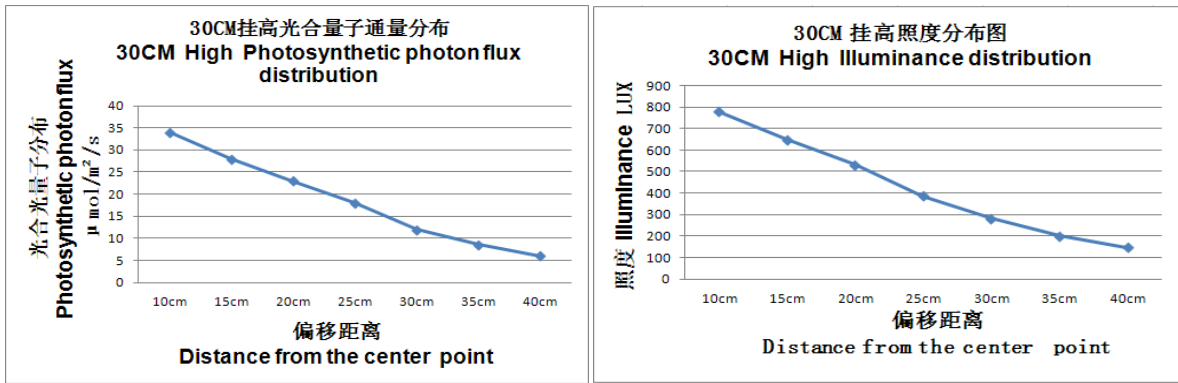

VQ-GLT8020W-10W

六、Installment Ways

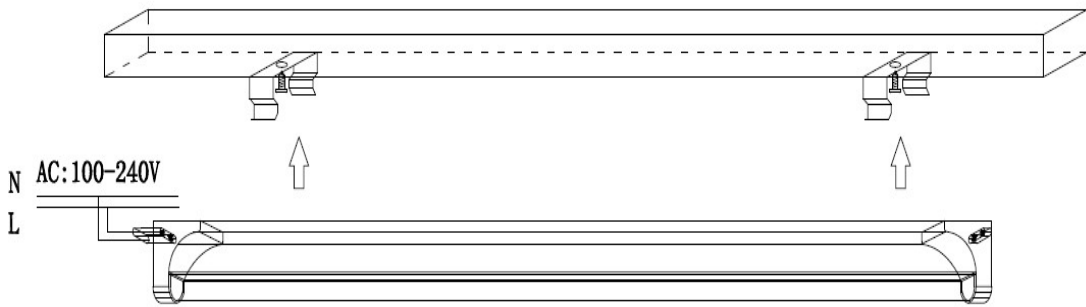

Picture4: installation instruction

七、Package parameter

Item Model	VQ-GLT8020W-21/22/23/24/25/26
The outer packing A weight	720g
The outer packing A size	1240* \varnothing 37.5mm
The outer packing weight B	18Kg
The outer packing size B	1250*280*250mm

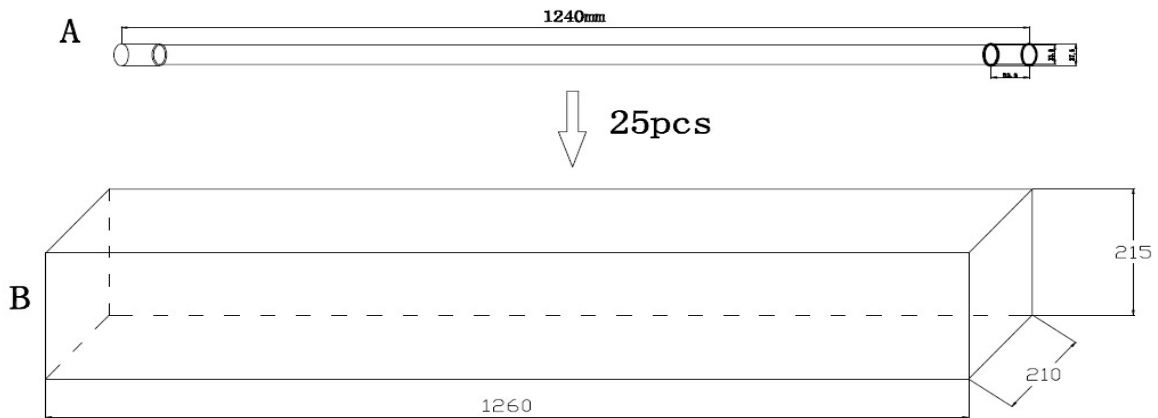

Picture5: Package Drawing

八、Attention

1. It works under the environmental of normal temperature.
2. Due to the function of no waterproof, it can't pour the water.
3. The parameter for LED ratio are our standard light ratio,just for your reference,customer can choose different LED ratio according to your different needs.

九、About us

Any problem in usage,please contact us in time. We will provide you both in time service and technical support
Our website: WWW.VANQLED.COM

After Sales service:

Two years warranty

We offer two years warranty for all VANQ products from the date of your purchasing. During period of warranty, VANQ offer free repairing service for the products which is broken and damaged in the case of correct operation. Customer also need to provide purchase invoice and return the product to us.

Please be noted free repairing service don't apply for below circumstance:

- 1, the product wasn't used according to the product's manual
- 2, Artificial imposed quality problems
- 3, Self-transformation cause failure of product

Please provide the pictures of the products which have quality problems by email ,we will do our best to help you solve the problem.

Customer feedback

Thanks for purchasing VANQ product! For better service, please leave your valuable comments to our product and service.

Contact information:



Tel: 0755-29042099 0755-29042092

Fax: 0755-82113652

Email: vanqled@vanqled.com

Website: www.vanqled.com

Address: 3/F , #B Building, DeBaoLi Industrial Zone, # 399 Jihua Road, Ban Tian Town, Longgang District, Shenzhen City, GuangDong Pro., China 518129

Product free-maintenance form

Customer name	
Address	
Purchase date	
Product code	
Product parameter	
others	

Product feedback form

Produce model:					
Produce code:					
Customer name		Date of receipt of goods		Contact info	
Address		Date of open the case		Date of fill the form	
Checking after open the case	Appear check				
	Electric al check				
The actual usage		date	Failure	Breakdown reason	The cumulative working hours
	First breakdow n				
	Other breakdow				



	n	
The actual use effect		
Comments and suggestions		

To improve our product and service, we are looking forward to your kind comments and feedbacks. Thanks!



HotLine: 0755-29042099 0755-29042092

fax: 0755-82113652

Email: vanqled@vanqled.com

Website: www.vanqled.com